



Z33-M060.51 K0,15 S15

High Frequency Spindle

Manual tool change

Identification of HF spindle

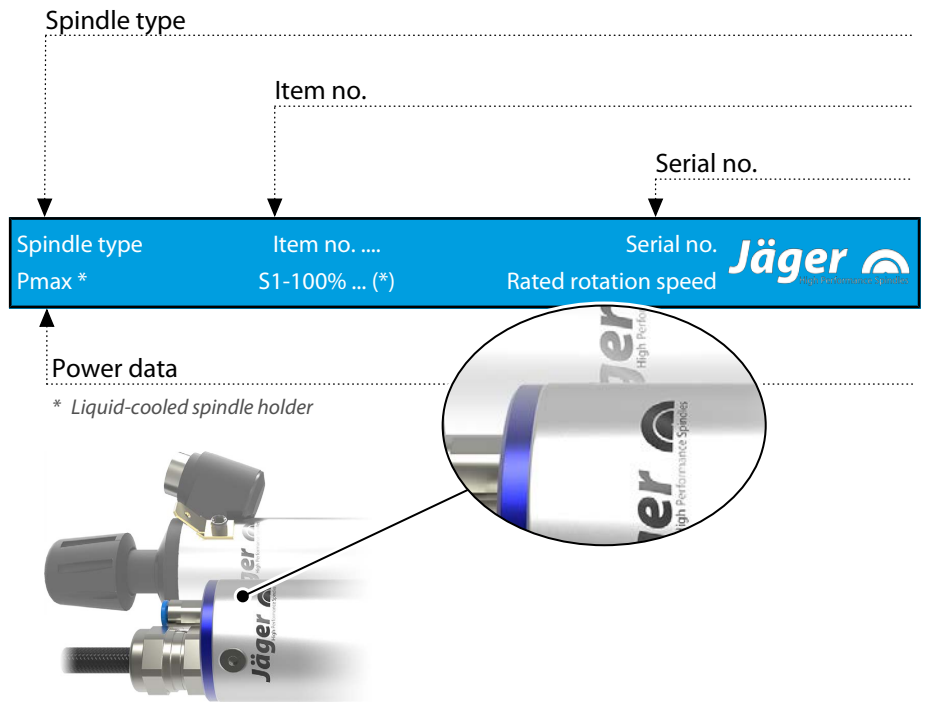

As we always ensure that our HF spindles are at the cutting edge of technological development, we reserve the right to make technical modifications and variations from the exact design described in the manual.

The text in this manual has been compiled with the utmost care. However, **Nakanishi Jaeger GmbH** cannot assume any legal responsibility or liability of any kind for incorrect information and any consequences thereof.

Translations and reproductions – including of extracts – are prohibited without the express written approval of **Nakanishi Jaeger GmbH**.



Contents:

Translation of the original manual

| | | | | | |
|----------|---------------------------------|-----------|-----------|---|-----------|
| 1 | Preliminary information | 4 | 8.2 | Diameter of media supply line | 22 |
| 1.1 | Purpose of the manual | 4 | 8.3 | Compressed air | 23 |
| 1.2 | Explanation of symbols used | 4 | 8.3.1 | Air purity classes (ISO 8573-1) | 23 |
| 2 | Transport and packaging | 5 | 8.3.2 | Setting the sealing air | 23 |
| 2.1 | Scope of supply of HF spindle | 5 | 9 | Commissioning | 24 |
| 2.1.1 | Optional accessories | 5 | 9.1 | Running-in schedule | 24 |
| 2.1.2 | Documentation supplied | 5 | 9.2 | Daily start-up | 25 |
| 2.2 | Packaging of HF spindle | 6 | 9.3 | Shutdown signal | 25 |
| 3 | Designated use | 6 | 9.4 | Commissioning after storage | 25 |
| 3.1 | Permissible types of machining | 6 | 10 | Tool change | 26 |
| 3.2 | Permissible materials | 6 | 10.1 | Clockwise | 26 |
| 4 | Safety instructions | 7 | 10.2 | Manual tool change | 26 |
| 4.1 | Safe working | 8 | 10.2.1 | Maximum tightening torques | 27 |
| 4.2 | Shutdown of HF spindle | 9 | 11 | Tools for high speed cutting | 28 |
| 4.3 | Installation and maintenance | 9 | 12 | Maintenance | 29 |
| 4.4 | Modification and repair | 9 | 12.1 | Ball bearings | 29 |
| 4.5 | Improper operation | 9 | 12.2 | Daily cleaning | 29 |
| 5 | Technical description | 10 | 12.2.1 | Before commencing work | 29 |
| 5.1 | Connections of HF spindle | 10 | 12.2.2 | With every tool change | 29 |
| 5.2 | Electrical connection | 10 | 12.2.3 | Every time the clamping device is changed | 30 |
| 5.3 | Cooling | 11 | 12.3 | In the case of storage | 30 |
| 5.3.1 | Cooling via spindle holder | 11 | 12.4 | Monthly maintenance | 30 |
| 5.4 | Sealing air | 11 | 12.5 | Long periods of storage | 30 |
| 6 | Technical Specifications | 12 | 12.6 | Maximum storage time | 30 |
| 6.1 | Dimensions | 13 | 13 | Dismantling | 31 |
| 6.2 | Motor data | 14 | 13.1 | Disposal and environmental protection | 31 |
| 6.2.1 | Performance Diagram | 15 | 14 | Service and repairs | 31 |
| 6.2.2 | Equivalent circuit diagram data | 15 | 14.1 | Service partners | 31 |
| | Parameter | 16 | 14.2 | Malfunctions | 32 |
| 6.3 | Motor data | 17 | 15 | Declaration of Incorporation | 35 |
| 6.3.1 | Performance Diagram | 18 | | | |
| 6.3.2 | Equivalent circuit diagram data | 18 | | | |
| | Parameter | 19 | | | |
| 6.4 | Wiring diagram | 20 | | | |
| 6.5 | Air-borne noise emissions | 21 | | | |
| 7 | Operating location | 21 | | | |
| 8 | Installation | 22 | | | |
| 8.1 | Installing the HF spindle | 22 | | | |

1 Preliminary information

The high frequency spindle (HF spindle) is a high quality precision tool for high speed machining.

1.1 Purpose of the manual

The manual is an important component of the HF spindle.

- Store the manual carefully.
- Make the manual available to all persons who work with the HF spindle.
- Read the documentation supplied in full.
- Before carrying out any work, read the corresponding section of the manual carefully again.

1.2 Explanation of symbols used

To enable quick classification of information, this manual uses visual aids in the form of symbols and text markings.

Notes are marked with a signal word and a colored box:



DANGER

Dangerous situation!

Results in serious injury or death.

- ▶ Measure to avert the danger.



WARNING

Dangerous situation!

May result in serious injury or death.

- ▶ Measure to avert the danger.



CAUTION

Dangerous situation!

May result in minor to moderate injury.

- ▶ Measure to avert the danger.



Note

May result in material damage. This warning symbol is not a warning for personal injury.

Tip

Tips indicate useful information for users.

2 Transport and packaging

Avoid strong vibrations or impacts during transportation, as these could damage the ball bearings of the HF spindle.

- Any damage reduces the accuracy of the HF spindle.
- Any damage restricts the functionality of the HF spindle.
- Any damage shortens the service life of the HF spindle.

2.1 Scope of supply of HF spindle

The following parts are supplied with the HF spindle:

- High Frequency Spindle
- Clamping nut
- Jaw wrench
- Hook wrench
- Transport packaging
- Check the high frequency spindle for completeness upon delivery.

2.1.1 Optional accessories

Available on request:

- Spindle holder
- Frequency converter
- Collet
- Felt cleaning taper
- Collet grease
- Further accessories on request.

Only approved accessories have been tested for operational safety and functionality.

- Do not use any other accessories – this may invalidate any warranty claims and compensation claims for damages.
- If the spindle holder is to be produced in-house, it is essential to contact **Nakanishi Jaeger GmbH** before starting production to request the tolerances and production plan for the spindle holder.

2.1.2 Documentation supplied

The documents listed below are supplied with the HF spindle:

- Manual
- The declaration of incorporation is part of the manual.
- Inspection protocol
- Check that the documentation supplied is complete when the spindle is delivered. If necessary, request a new copy.

2.2



Packaging of HF spindle

All transport packaging materials can be recycled in appropriate disposal facilities.

3

Designated use

The HF spindle is an “incomplete machine” in accordance with the Machinery Directive and cannot perform any function independently. The HF spindle can only be operated in conjunction with a machine tool and a frequency converter.

3.1

Permissible types of machining

The HF spindle has been developed only for the following types of machining.

- Cutting
 - Drilling
 - Engraving
 - Grinding
- ➔ Contact **Nakanishi Jaeger GmbH** if other types of machining are required.

3.2

Permissible materials

The HF spindle has been developed only for the following materials.

- Metals (such as alloys, cast metals etc.)
 - Sintered materials
 - Plastics
 - Wood
 - Graphite
 - Stone (marble, etc.)
 - Paper and cardboard
 - Circuit boards
 - Glass and ceramic
- ➔ Contact **Nakanishi Jaeger GmbH** if other materials are to be machined.

4 Safety instructions

The high frequency spindle is a state of the art product and is safe to operate.

However, the HF spindle may pose a risk in the following cases:

- If it is installed by untrained personnel.
- If it is used incorrectly.
- If it is not used in accordance with its intended use.

The high frequency spindle may only be installed, commissioned, and maintained by specialist personnel.

Definition: Specialist personnel are persons who are familiar with the assembly, installation, commissioning, and operation of the product and have the relevant qualifications for their area of activity. The operator must closely control the responsibility, training, and monitoring of these personnel.



DANGER: Due to explosion.

HF spindles are not approved for use in areas at risk of explosion. Use in such areas may result in explosions.

- ▶ Do not use the HF spindle in potentially explosive atmospheres.



DANGER: Due to flying parts.

The HF spindle operates at high speeds and may therefore be flung away by these.

- ▶ Operate the HF spindle only if it is installed in the machine or system in a fixed manner.



Note: Adhere to the limit values.

- ▶ Observe the limit values specified in the technical data.



Note: Take account of the machine.

- ▶ Observe the manual of the machine in which the HF spindle is installed.
- ▶ Observe all safety instructions specified by the machine manufacturer.
- ▶ Ensure that the machine does not cause any hazards (e.g. uncontrolled movements). Do not install the HF spindle in the machine until this has been done.



Note. Do not damage the HF spindle.

- ▶ Any damage reduces the accuracy of the HF spindle.
- ▶ Any damage restricts the functionality of the HF spindle.
- ▶ Any damage shortens the service life of the HF spindle.

4.1

Safe working

Observe all safety instructions set out in the manual, the applicable national accident prevention regulations, and the valid company work, operation, and safety guidelines.



DANGER: Due to flying parts.

Tools that are not clamped correctly will be flung away by the centrifugal forces that occur during machining.

- ▶ Use the full clamping depth of the collet.
- ▶ Clamp the tool securely.



DANGER: Due to flying parts.

If the wrong rotational direction is used, the clamping system releases and the tool is flung away.

- ▶ It is essential to adhere to the rotational direction of the HF spindle.



WARNING: Risk of injury due to flying parts.

The HF spindle operates at high speeds which may cause chips to fly out with great force.

- ▶ Never remove the protective devices of the machine or system.
- ▶ Always wear protective goggles during work.

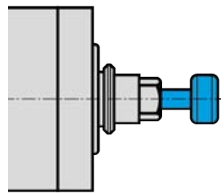

Example of design: Inserting the shank

Note: Ensure functionality.

- ▶ Never operate the HF spindle without a clamped tool shank.

If no tool shank is clamped:

- The clamping system is damaged by the centrifugal forces.
- The clamping system is shifted.
- The balance of the HF spindle is affected.
- The bearing is damaged.

- ➔ Take the relevant measures to protect against splashes and spray according to the type of machining, the type of material being machined, and the type of tool selected.
 - ↳ Observe the manual of the machine in which the HF spindle is installed.
- ➔ Obtain the maximum circumferential speeds of the tools used from the tool supplier.

Single-point tools are not suitable for high speed cutting.

If they are required for production reasons:

- ➔ Only use a balanced tool.
 - ↳ DIN ISO 1940
 - ↳ Balance grade 2,5

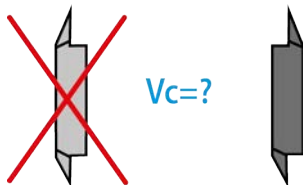



The tool cutting diameter (X) must not be greater than the maximum clamping range (Y).

- ➔ Always clamp the tool so that it is as short as possible.
- ➔ Keep the dimension (Z) small.
- ➔ (Y) See section: Technical Specifications [▶ 12].

4.2

Shutdown of HF spindle

The procedure for shutting down the high frequency spindle for installation and maintenance work is as follows:

- ➔ Completely disconnect the power supply.
- ➔ Completely disconnect the media supply (air and liquid).
- ➔ Make sure that the shaft of the HF spindle has come to an absolute standstill.

If the HF spindle is being shut down to be cleaned:

- ➔ Reconnect only the sealing air.

Tip: Forward the data to the controller.

- ▶ Use the option on the frequency converter of detecting the shutdown signal from the shaft and forwarding this to the machine controller for evaluation.

4.3

Installation and maintenance

- ➔ Carry out installation, cleaning, and maintenance work only after shutting down the HF spindle and after the shaft has come to a standstill.
- ➔ Install all safety and protective devices of the machine immediately after completing work.

4.4

Modification and repair

Modifications or alterations to the HF spindle are only permitted after prior consultation with **Nakanishi Jaeger GmbH**.

Only the service partners listed in the "Service and repair [▶ 31]" section are authorized to open and repair the HF spindle.

Only approved accessories have been tested for operational safety and functionality.

4.5

Improper operation

The high frequency spindle is only safe to operate for its designated use.

- ➔ Observe the safety instructions in all sections of the manual to prevent hazards to persons, the environment, the machine, or the HF spindle itself.

Failure to observe the safety instructions may invalidate any warranty claims and compensation claims for damages.

5 Technical description

5.1 Connections of HF spindle

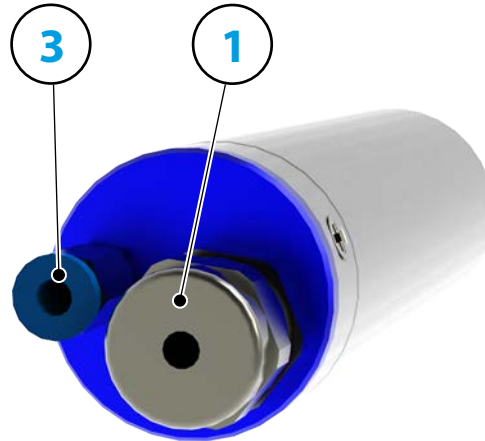

1 Electrical connection

3 Sealing air

M5

5.2 Electrical connection

The HF spindle may only be operated with a frequency converter (FC).

- ➔ Check whether the current, voltage, and frequency data of the HF spindle match the raw data for the frequency converter.
- ➔ Use a motor supply line that is as short as possible.
- ➔ Adjust the speed of the HF spindle using the FC.
- ➔ Refer to the frequency converter manual for further information.

The FC detects the following operating states of the HF spindle, depending on the version:

- HF spindle rotating.
- HF spindle too hot.
- HF spindle at a standstill, etc.

The FC forwards the operating states of the HF spindle to the machine controller.

5.3

Cooling

The HF spindle does not feature built-in cooling. However, this means that it has a lower power than an HF spindle with cooling.

Note: Extension of the service life through heat dissipation.

Heat is produced during operation of the HF spindle. The temperature of the HF spindle should not exceed + 45° C as this shortens the service life of the bearing.

- ▶ Check the temperature of the HF spindle on the housing.
- ▶ Dissipate the heat using the spindle holder.

5.3.1

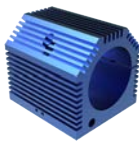

Example of design:
Air-cooled spindle holder

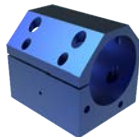

Example of design:
Liquid-cooled spindle holder

Cooling via spindle holder

To increase the power of the HF spindle, the heat generated must be dissipated via the spindle holder (optional accessory).

If the spindle holder is to be produced in-house:

- ➔ Contact **Nakanishi Jaeger GmbH**.
- ➔ Request the tolerances and production plan for the spindle holder.
- ➔ Produce the spindle holder from a thermally-conductive material (e.g. aluminum).
- ➔ Observe the dimensions of the clamping range in the Technical Specifications [▶ 12] section. Make sure that the HF spindle is enclosed by the spindle holder to the specified length.
- ➔ Add cooling fins or holes (greater heat dissipation) to the external surface of the spindle holder.

5.4

Sealing air

For guidelines on air quality, see "Air purity classes (ISO 8573-1) [▶ 23]" section.

The sealing air prevents foreign bodies such as chips and liquids (e.g. emulsions) from entering the HF spindle.

- ➔ Check that air escapes at the front between the housing and the rotating parts of the HF spindle.

6

Technical Specifications

Bearings

| | |
|---------------------------|------------------|
| Hybrid ball bearing (pcs) | 2 (front) |
| Steel ball bearing (pcs) | 1 (rear) |
| Lifetime lubricated | maintenance free |

**Power values
Spindle holder cooled**

| | Pmax./5s | S6-60% | S1-100% | |
|-------------|----------|--------|---------|------|
| Rated power | 0,55 | 0,5 | 0,43 | [kW] |
| Torque | 0,1014 | 0,0931 | 0,0817 | [Nm] |
| Voltage | 57 | 57 | 57 | [V] |
| Current | 10 | 9,4 | 8,6 | [A] |

**Power values
Uncooled**

| | Pmax./5s | S6-60% | S1-100% | |
|-------------|----------|--------|---------|------|
| Rated power | 0,4 | 0,34 | 0,25 | [kW] |
| Torque | 0,08 | 0,075 | 0,06 | [Nm] |
| Voltage | 47 | 47 | 44 | [V] |
| Current | 8,2 | 7,8 | 8,1 | [A] |

Motor data

| | |
|--|---|
| Motor technology | 3-phase asynchronous drive (no brushes or sensors) |
| Frequency | 1.000 Hz |
| Motor poles (pairs) | 1 |
| Rated rotation speed | 60.000 rpm |
| Acceleration/braking value Per second | 10 000 rpm (other values by consultation) |

Characteristics

| | |
|--|-----------------------------|
| Housing | Aluminium |
| Housing diameter | 33 mm |
| Cooling | Uncooled |
| Heat dissipation | Via the spindle holder |
| Housing temperature | < + 45° C |
| Ambient temperature | + 10°C ... + 45°C |
| Sealing air | |
| Protection category (sealing air turned on) | IP54 |
| Tool change | Manual tool change |
| Collet type | ER 8 |
| | Optional accessories |
| Clamping range up to | 5 mm (13/64") |

| | |
|---------------------|---|
| Clockwise | |
| Coupler plug | 7-pin (Amphenol C16-1) Cable length 0,15 m |
| Weight | ~ 0,62 kg |
| Inner taper run out | < 1 μ |

6.1 Dimensions

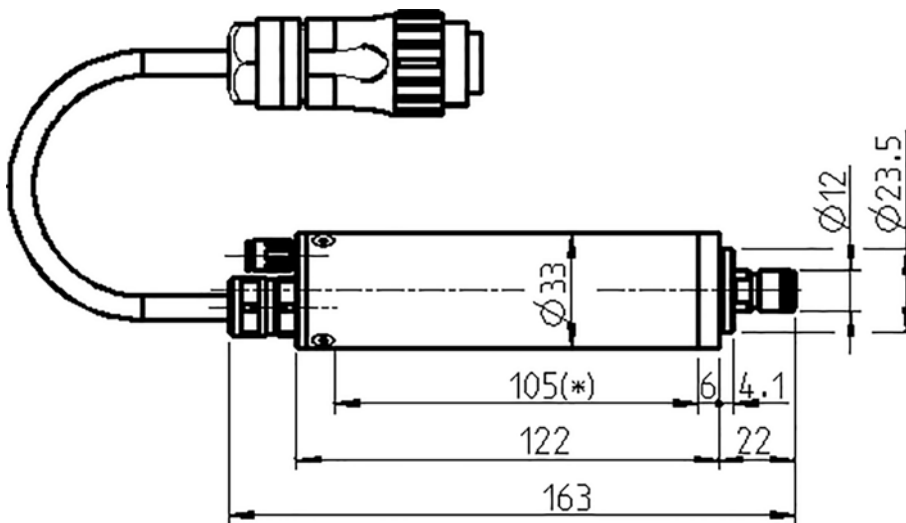

(*) = Clamping range

6.2

The power values (S1, S6, S2) are valid for sinusoidal currents and voltages.

The power values of the HF spindle are dependent on the frequency converter used and may vary from the indicated values.

Motor data

| | |
|----------------------------------|---|
| Spindle characteristic curve | 1016 |
| Motor technology | AC Motor |
| Motor type | ACM 26/15/45-2E |
| Rated power | 0,43 kW |
| Rated rotation speed | 60.000 rpm |
| Cooling | Spindle holder cooled (liquid-cooled spindle holder) |
| Heat dissipation | via the mount |
| Motor temperature | < 100°C |
| Winding resistance (phase-phase) | 0,476 Ω |
| Power dissipation | 174 W – max. (S1) |

S1-100%

| | | | | | |
|----------------------|--------|--------|--------|--------|-----|
| Rated rotation speed | 5 000 | 10 000 | 30 000 | 60 000 | rpm |
| Speed | 2 905 | 7 888 | 27 887 | 57 985 | rpm |
| Frequency | 83 | 167 | 500 | 1 000 | Hz |
| Rated power | 0,025 | 0,066 | 0,223 | 0,431 | kW |
| Torque | 0,0817 | 0,0802 | 0,0765 | 0,0709 | Nm |
| Voltage | 7 | 12 | 29 | 57 | V |
| Current | 8,2 | 8,2 | 8,2 | 8,6 | A |
| cos φ | 0,93 | 0,87 | 0,8 | 0,73 | |

S6-60%

| | | | | | |
|----------------------|--------|--------|--------|--------|-----|
| Rated rotation speed | 5 000 | 10 000 | 30 000 | 60 000 | rpm |
| Speed | 2 720 | 7 755 | 27 744 | 57 588 | rpm |
| Frequency | 83 | 167 | 500 | 1 000 | Hz |
| Rated power | 0,027 | 0,074 | 0,249 | 0,5 | kW |
| Torque | 0,0931 | 0,091 | 0,0857 | 0,083 | Nm |
| Voltage | 8 | 12 | 30 | 57 | V |
| Current | 9 | 9 | 9 | 9,4 | A |
| cos φ | 0,94 | 0,88 | 0,81 | 0,76 | |

S2-Pmax./5 s

| | | | | | |
|----------------------|-------|--------|--------|--------|-----|
| Rated rotation speed | 5 000 | 10 000 | 30 000 | 60 000 | rpm |
| Speed | 2 769 | 7 814 | 27 870 | 57 935 | rpm |
| Frequency | 83 | 167 | 500 | 1 000 | Hz |
| Rated power | 0,03 | 0,083 | 0,283 | 0,558 | kW |
| Torque | 0,104 | 0,1014 | 0,0969 | 0,092 | Nm |
| Voltage | 8 | 13 | 30 | 57 | V |
| Current | 10 | 10 | 10 | 10 | A |
| cos φ | 0,94 | 0,88 | 0,8 | 0,77 | |

Note on operation with static frequency converters:

For operation with a frequency converter, the effective fundamental voltage must correspond to the specified motor voltage.

The measured currents may be greater than the specified values due to the harmonic content.

6.2.1 Performance Diagram

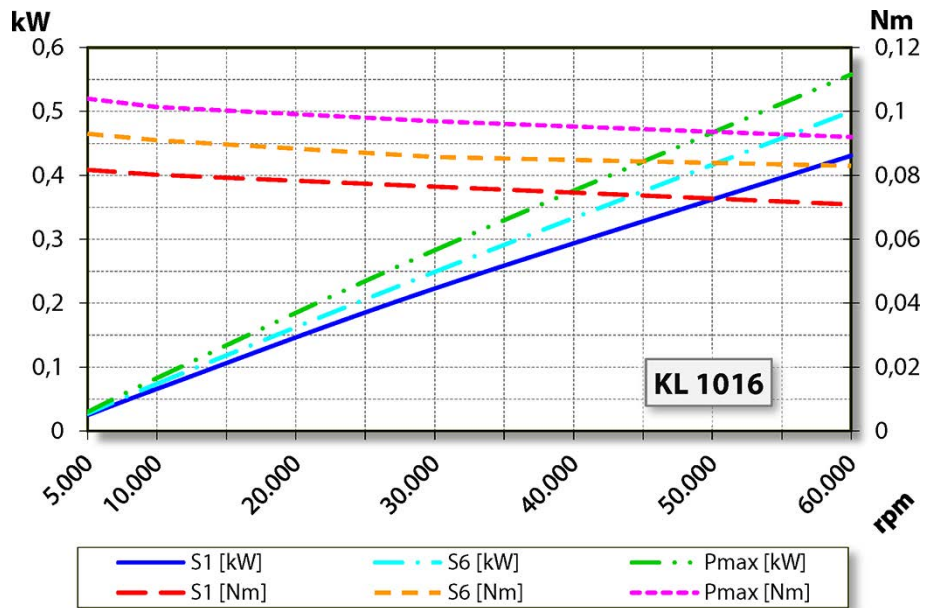

6.2.2 Equivalent circuit diagram data

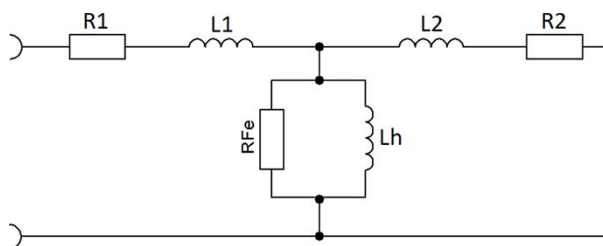

Note: Damage due to incorrect performance data.

The values of the parameters relate exclusively to the motor.

► HF spindle values: See tables S1-100%, S6-60% and S2-Pmax.

| Parameter* | Meaning | Value | Unit |
|------------|--|-----------------------|------------------|
| p0304 | Rated voltage (phase-phase) | 57 | Vrms |
| p0305 | Rated current | 8,6 | Arms |
| p0307 | Rated power | 0,431 | kW |
| p0308 | Rated power factor | 0,73 | cos φ |
| p0310 | Rated frequency | 1.000 | Hz |
| p0311 | Rated speed | 57.958 | rpm |
| --- | Rated power loss | 174 | W |
| --- | Rated rotation speed | 60.000 | rpm |
| p0312 | Rated torque | 0,071 | Nm |
| p0314 | Motor poles (pairs) | 1 | --- |
| p0320 | Rated magnetization current | 5,17 | Arms |
| p0322 | Maximum speed | 60.000 | rpm |
| p0326 | Stalling torque correction factor | 100 | % |
| p0335 | Cooling type | Spindle holder cooled | |
| p0341 | Moment of inertia | 0,0000053 | kgm ² |
| p0348 | Field weakening operating speed VDC=600V | 253.070 | rpm |
| p0350 | Stator resistance, cold (strand) | 0,238 | Ω |
| p0353 | Series inductance (strand) | 0 | mH |
| p0354 | Rotor resistance, cold | 0,136 | Ω |
| p0356 | Stator stray inductance | 0,058 | mH |
| p0358 | Rotor stray inductance | 0,083 | mH |
| p0360 | Main inductance | 0,89 | mH |
| p0604 | Motor temperature warning threshold | 80 | °C |
| p0605 | Motor temperature fault threshold | 100 | °C |
| p0640 | Current limit | 10 | Arms |
| p1800 | Pulse frequency | 16 | kHz |
| --- | DC link voltage | 80 | VDC |
| --- | Series capacitance | | μF |
| --- | Maximum voltage | | V |
| --- | Idle reduction | | % |
| --- | Stator stray reactance X1 | 0,367 | Ω |
| --- | Rotor stray reactance X2 | 0,519 | Ω |
| --- | Main field reactance Xh | 5,59 | Ω |

(*) Parameters for Siemens SINAMICS 120

6.3

Motor data

The power values (S1, S6, S2) are valid for sinusoidal currents and voltages.

The power values of the HF spindle are dependent on the frequency converter used and may vary from the indicated values.

| | |
|----------------------------------|------------------|
| Spindle characteristic curve | 1012 |
| Motor technology | AC Motor |
| Motor type | ACM 26/15/45-2E |
| Rated power | 0,25 kW |
| Rated rotation speed | 60.000 rpm |
| Cooling | Uncooled |
| Heat dissipation | via the mount |
| Motor temperature | < 100 °C |
| Winding resistance (phase-phase) | 0,476 Ω |
| Power dissipation | 69 W – max. (S1) |

Measured values: S1-100%

| | | | | | | | | |
|----------------------|--------|--------|--------|--------|--------|--------|--------|-----|
| Rated rotation speed | 5 000 | 10 000 | 20 000 | 30 000 | 40 000 | 50 000 | 60 000 | rpm |
| Speed | 3 953 | 8 458 | 18 000 | 27 953 | 37 806 | 47 954 | 58 182 | rpm |
| Frequency | 83 | 167 | 333 | 500 | 667 | 833 | 1 000 | Hz |
| Rated power | 0,022 | 0,053 | 0,112 | 0,169 | 0,207 | 0,232 | 0,245 | kW |
| Torque | 0,0536 | 0,0603 | 0,0595 | 0,0577 | 0,0522 | 0,0462 | 0,0403 | Nm |
| Voltage | 8 | 11 | 18 | 25 | 31 | 37 | 44 | V |
| Current | 8,1 | 6,7 | 6,8 | 6,8 | 6,5 | 6,1 | 5,6 | A |
| cos φ | 0,85 | 0,84 | 0,83 | 0,81 | 0,81 | 0,79 | 0,77 | |

Measured values: S6-60%

| | | | | | | | | |
|----------------------|--------|--------|--------|--------|--------|--------|--------|-----|
| Rated rotation speed | 5 000 | 10 000 | 20 000 | 30 000 | 40 000 | 50 000 | 60 000 | rpm |
| Speed | 3 512 | 7 925 | 17 928 | 27 956 | 37 866 | 47 504 | 57 580 | rpm |
| Frequency | 83 | 167 | 333 | 500 | 667 | 833 | 1 000 | Hz |
| Rated power | 0,023 | 0,062 | 0,135 | 0,201 | 0,257 | 0,303 | 0,343 | kW |
| Torque | 0,0629 | 0,0751 | 0,0718 | 0,0686 | 0,0649 | 0,061 | 0,057 | Nm |
| Voltage | 7 | 11 | 19 | 28 | 35 | 40 | 47 | V |
| Current | 6,8 | 7,8 | 7,7 | 7,5 | 7,4 | 7,3 | 7 | A |
| cos φ | 0,91 | 0,87 | 0,82 | 0,8 | 0,79 | 0,81 | 0,8 | |

Measured values: S2-Pmax./5 s

| | | | | | | | | |
|----------------------|-------|--------|--------|--------|--------|--------|--------|-----|
| Rated rotation speed | 5 000 | 10 000 | 20 000 | 30 000 | 40 000 | 50 000 | 60 000 | rpm |
| Speed | 3 462 | 8 127 | 18 020 | 28 161 | 38 025 | 47 687 | 57 722 | rpm |
| Frequency | 83 | 167 | 333 | 500 | 667 | 833 | 1 000 | Hz |
| Rated power | 0,026 | 0,068 | 0,147 | 0,222 | 0,287 | 0,349 | 0,406 | kW |
| Torque | 0,073 | 0,0799 | 0,0778 | 0,0754 | 0,072 | 0,0699 | 0,067 | Nm |
| Voltage | 7 | 12 | 19 | 28 | 35 | 40 | 47 | V |
| Current | 7,7 | 8,2 | 8,2 | 8,1 | 8 | 8,1 | 8 | A |
| cos φ | 0,91 | 0,87 | 0,83 | 0,8 | 0,8 | 0,82 | 0,81 | |

Note on operation with static frequency converters:

For operation with a frequency converter, the effective fundamental voltage must correspond to the specified motor voltage.

The measured currents may be greater than the specified values due to the harmonic content.

6.3.1 Performance Diagram

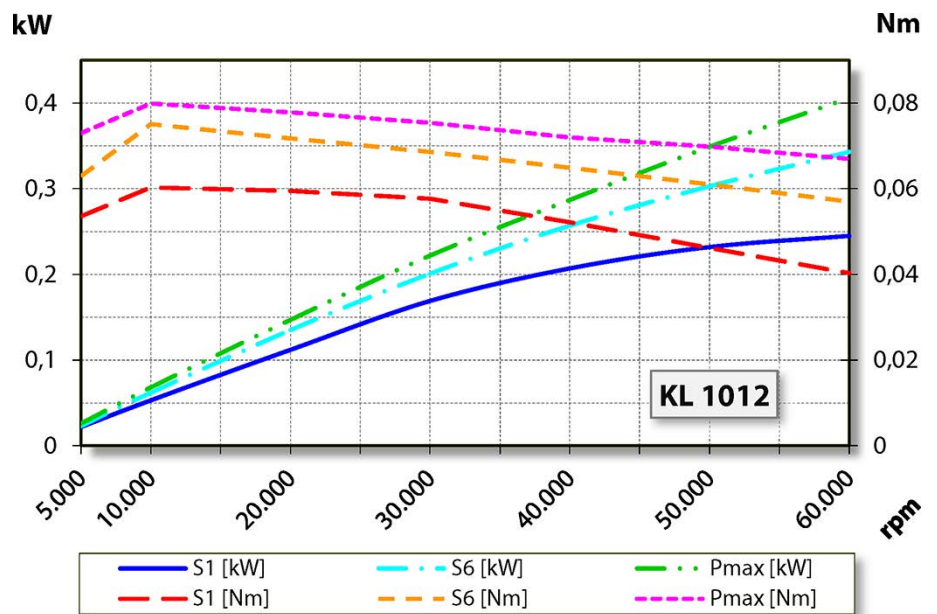

6.3.2 Equivalent circuit diagram data

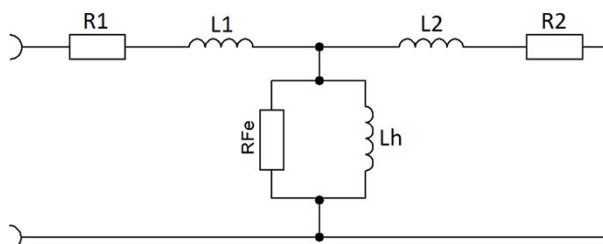



Note: Damage due to incorrect performance data.

The values of the parameters relate exclusively to the motor.

► HF spindle values: See tables S1-100%, S6-60% and S2-Pmax.

| Parameter* | Meaning | Value | Unit |
|------------|---|-----------|------------------|
| p0304 | Rated voltage (phase-phase) | 44,4 | Vrms |
| p0305 | Rated current | 5,6 | Arms |
| p0307 | Rated power | 0,245 | kW |
| p0308 | Rated power factor | 0,77 | cos φ |
| p0310 | Rated frequency | 1.000 | Hz |
| p0311 | Rated speed | 58.182 | rpm |
| --- | Rated power loss | 69 | W |
| --- | Rated rotation speed | 60.000 | rpm |
| p0312 | Rated torque | 0,04 | Nm |
| p0314 | Motor poles (pairs) | 1 | --- |
| p0320 | Rated magnetization current | 2,71 | Arms |
| p0322 | Maximum speed | 60.000 | rpm |
| p0326 | Stalling torque correction factor | 100 | % |
| p0335 | Cooling type | | Uncooled |
| p0341 | Moment of inertia | 0,0000053 | kgm ² |
| p0348 | Field weakening operating speed VDC=600V | 324.887 | rpm |
| p0350 | Stator resistance, cold (strand) | 0,238 | Ω |
| p0353 | Series inductance (strand) | 0 | mH |
| p0354 | Rotor resistance, cold | 0,136 | Ω |
| p0356 | Stator stray inductance | 0,087 | mH |
| p0358 | Rotor stray inductance | 0,121 | mH |
| p0360 | Main inductance | 1,323 | mH |
| p0604 | Motor temperature warning threshold | 60 | °C |
| p0605 | Motor temperature fault threshold | 70 | °C |
| p0640 | Current limit | 8 | Arms |
| p1800 | Pulse frequency | 16 | kHz |
| --- | DC link voltage | 65 | VDC |
| --- | Series capacitance | | μF |
| --- | Maximum voltage | | V |
| --- | Idle reduction | | % |
| --- | Stator stray reactance X1 | 0,546 | Ω |
| --- | Rotor stray reactance X2 | 0,758 | Ω |
| --- | Main field reactance Xh | 8,31 | Ω |

(*) Parameters for Siemens SINAMICS 120

6.4 Wiring diagram

Note: Do not change the ex-works configuration.

Any change may cause overvoltage on the electrical components (e.g. PTC, differential magneto resistor).

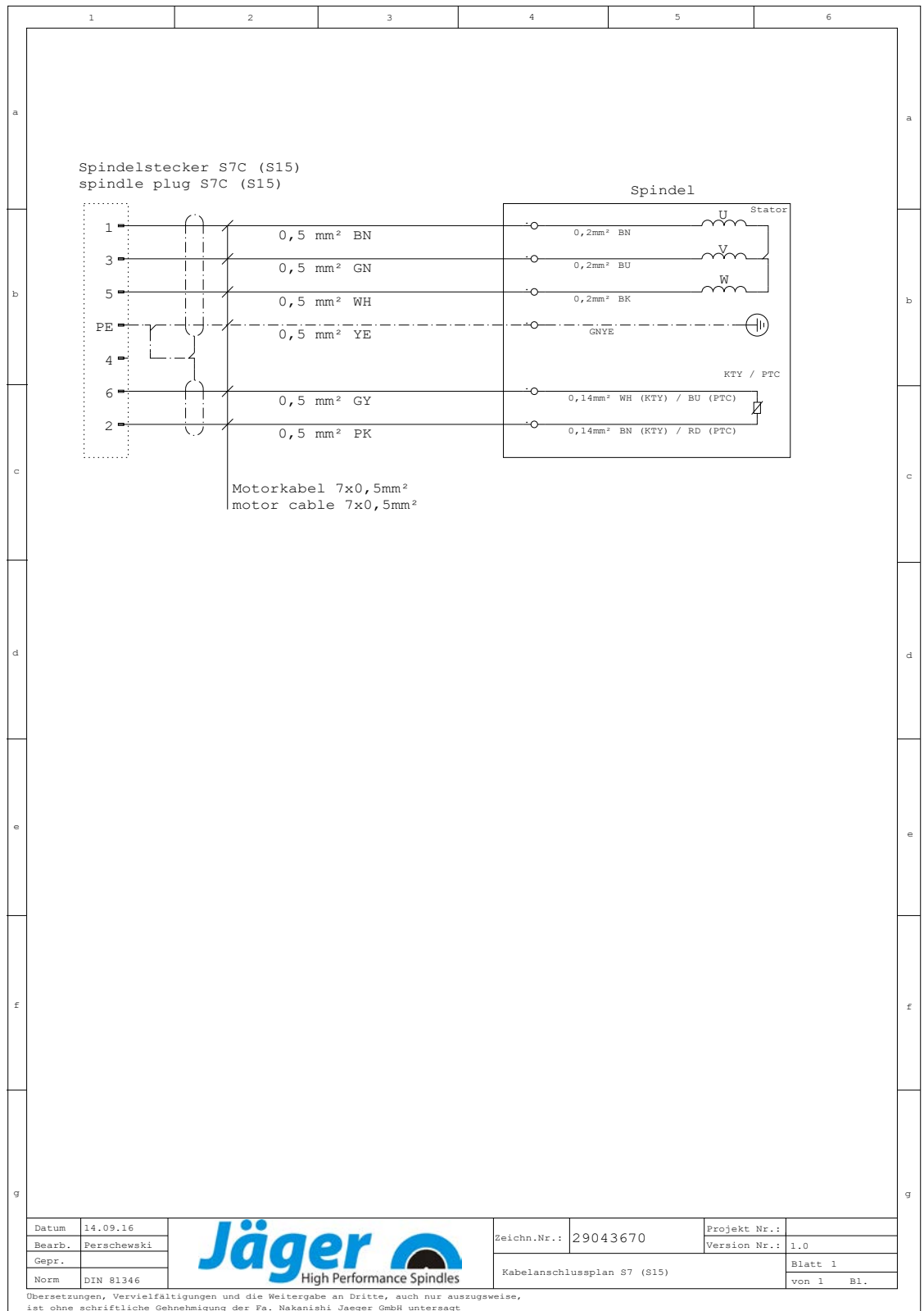

6.5

Air-borne noise emissions



CAUTION: Noise has an impact on health.

▶ Only operate the HF spindle if you are wearing hearing protection.

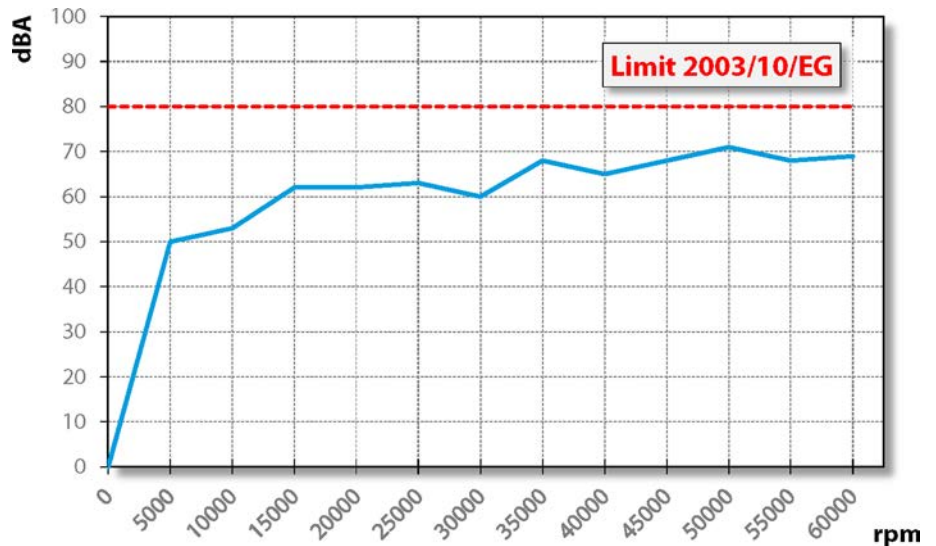

7

Operating location



DANGER: Due to flying parts.

If the HF spindle is incorrectly attached, it may come loose during operation and be flung away by the forces that occur.

▶ Clamp the HF spindle firmly.



WARNING: Risk of injury due to flying parts.

The HF spindle operates at high speeds which may cause chips to fly out with great force.

- ▶ Never remove the protective devices of the machine or system.
- ▶ Always wear protective goggles during work.

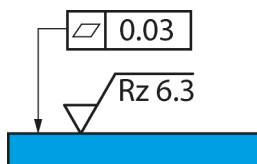

Example of design: Mounting surface

Note the following points before installing the HF spindle:

- ➡ Make sure that the correct spindle holder for the HF spindle is fitted in the machine.
- ➡ Check the connecting hoses for damage.
- ➡ Check the connecting cables for damage.
- ➡ Only use undamaged hoses and cables.
- ➡ Do not allow the HF spindle to run in the vicinity of a heat source.

8

Installation

Before installation:

- Check the HF spindle for damage and ensure that it is complete.

If the HF spindle has been stored for a long period:

- Carry out all steps in the Commissioning after storage section.

8.1

Installing the HF spindle

Complete the following steps in sequence to install the HF spindle:

- Remove the sealing plugs that protect the connections against damage and contamination during transportation.
- Instead of these sealing plugs, install the appropriate hose fittings.
- Install the corresponding hoses in the hose fittings
- Make sure that the connections are flexible and free of strain.
- Seal all connections for compressed air axially in relation to the tightening direction.
- If the HF spindle is equipped with sealing air:
 - ✎ Make sure that no air flow can occur in the bearing area.
 - ✎ Always use sealed cable boxes when connecting electrical lines.
- Mount the HF spindle on the machine.
- Connect the hoses to the connection of the respective media.
- Connect the connector of the operating connection lines to the relevant connection of the HF spindle and to the frequency converter.
- Lock the connectors.

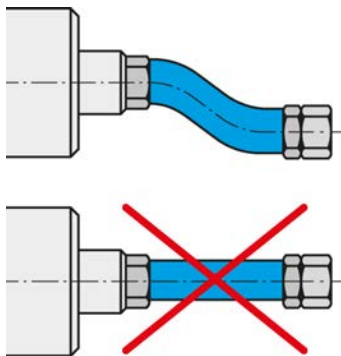

Connect media and cables with a flexible connection.

8.2

Diameter of media supply line

- The nominal size of the media supply lines can be found in the following table:

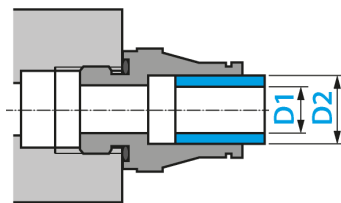

| DN | Medium | D1 | | D2 | |
|-----|----------------|--------|-------------------|------|-------------------|
| 2.8 | Compressed air | 2.8 mm | $\frac{7}{64}$ " | 4 mm | $\frac{5}{32}$ " |
| 4 | Compressed air | 4 mm | $\frac{5}{32}$ " | 6 mm | $\frac{15}{64}$ " |
| 6 | Compressed air | 6 mm | $\frac{15}{64}$ " | 8 mm | $\frac{5}{16}$ " |

8.3 Compressed air

8.3.1 Air purity classes (ISO 8573-1)

| | |
|-------------------|---|
| Solid impurities | Class 3 Filter grade at least 5 µm for solids |
| Water content | Class 4 Max. pressure dew point +3 °C |
| Total oil content | Class 3 Max. oil content 1 mg/m ³ |

8.3.2 Setting the sealing air

For guidelines on air quality, see "Air purity classes (ISO 8573-1) [▶ 23]" section.

The adjustment value for the sealing air depends on the hose diameter and length.

- ➔ Hose diameter: DN 2.8
- ➔ The setting value can be found in the following diagram.
- ➔ To ensure effective control, turn on the sealing air and cooling when turning on the machine. This protects the HF spindle even when it is stationary.

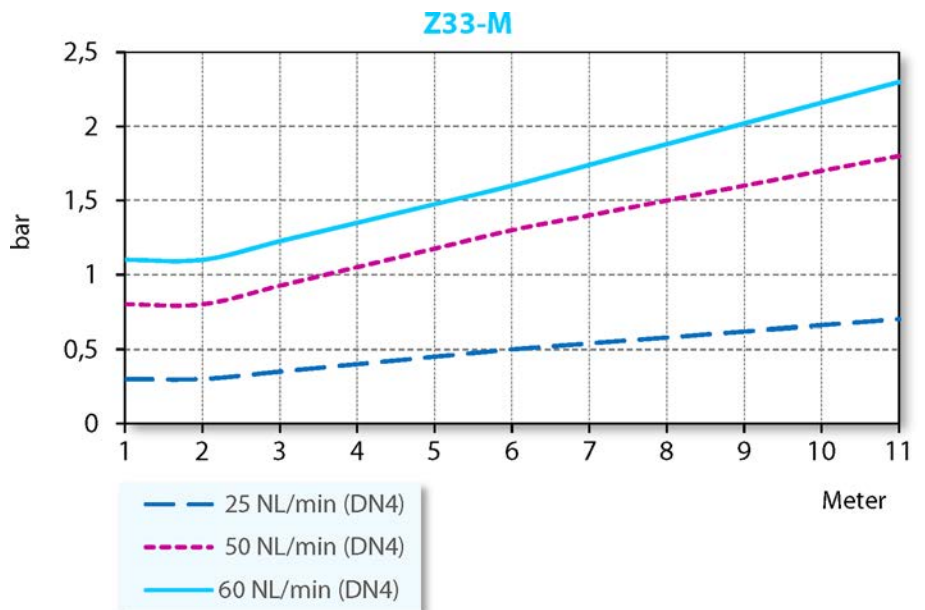

| | |
|----------------------------|----------------------------|
| Lowest sealing air supply | Dry machining |
| Medium sealing air supply | Machining with spray water |
| Highest sealing air supply | Machining with hose water |

9

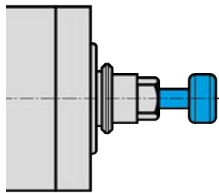

Example of design: Inserting the shank

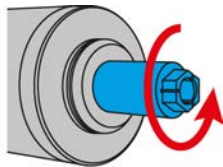

Example of design: Clockwise

9.1

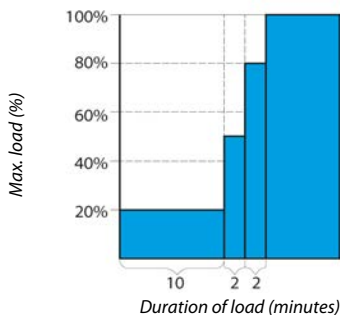

Commissioning

DANGER: Due to flying parts.

If the speed is selected incorrectly, the HF spindle or the tool may be destroyed and their fragments may be flung out.

- ▶ Note the maximum speed for the selected tool.
- ▶ Note the maximum speed for the HF spindle.
- ▶ The maximum permissible speed of the HF spindle for commissioning / processing is always the **lowest** specified speed.

Note: Ensure functionality.

- ▶ Never operate the HF spindle without a clamped tool shank.

If no tool shank is clamped:

- The clamping system is damaged by the centrifugal forces.
- The clamping system is shifted.
- The balance of the HF spindle is affected.
- The bearing is damaged.

- ➔ Turn the shaft of the spindle at least ten times by hand.

Running-in schedule

- ➔ Put the HF spindle into operation with a clamped tool (without machining) for approx. 10 minutes.
- ➔ The speed in this case should be no more than 20% of the maximum permissible speed for the HF spindle.
 - ↪ See definition: Max. permissible speed
- ➔ Allow the HF spindle to run for approx. 2 minutes at a maximum of 50% of the maximum permissible speed.
- ➔ Operate the HF spindle for approx. 2 more minutes at a maximum of 80% of the maximum permissible speed.

The HF spindle is now ready for operation.

9.2 Daily start-up

Proceed as follows to preheat the grease lubrication of the bearing and to protect it:

- ➔ Operate the HF spindle with a clamped tool (without machining).
 - ⚙ Approx. 2 minutes.
 - ⚙ At maximum 50 % of the maximum permissible speed.
(See Commissioning [▶ 24] section)

This brings the HF spindle to its operating temperature.

9.3 Shutdown signal

Use the option on the frequency converter of detecting the shutdown signal from the shaft and forwarding this to the machine controller for evaluation.

9.4 Commissioning after storage

- ➔ Do not put the HF spindle into operation until its temperature has adjusted from the temperature of the storage location to the temperature of the usage location.
 - ⚙ The temperature difference between the HF spindle and the usage location should not exceed 10°C.
- ➔ Carry out all steps in the "Maintenance [▶ 29]" section.
- ➔ Operate the HF spindle at a maximum of 50 % of the max. permissible speed for approx. 5 minutes.
 - ⚙ See Commissioning [▶ 24] section
- ➔ Operate the HF spindle for approx. 2 more minutes at a maximum of 80 % of the maximum permissible speed.

This preheats the grease lubrication of the bearing and protects it.

10

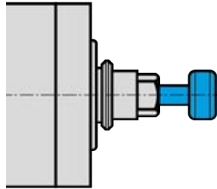

Example of design: Inserting the shank

10.1

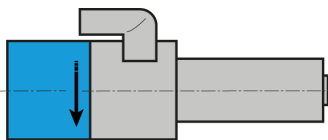

Sample illustration:
Direction of rotation indication

10.2

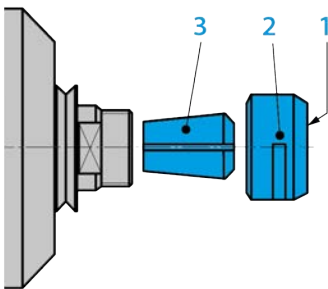

Tool change

CAUTION: Danger of being drawn in by rotating shaft.

If the shaft is still rotating, fingers and hands may be drawn in and crushed.

- ▶ Only change the tool if the shaft is at a standstill.

Note: Ensure functionality.

- ▶ Never operate the HF spindle without a clamped tool shank.

If no tool shank is clamped:

- The clamping system is damaged by the centrifugal forces.
- The clamping system is shifted.
- The balance of the HF spindle is affected.
- The bearing is damaged.

Clockwise

The HF spindle clamping system is designed for clockwise rotation.

- ➡ Only use tools with the correct direction of rotation for the HF spindle.
- ➡ Only use tool mounts with the correct HF spindle direction of rotation.
- ➡ Set the direction of rotation of the HF spindle on the FC in accordance with the arrow display on the HF spindle.

Manual tool change

- | | |
|---|-----------------------------|
| 1 | End face |
| 2 | Clamping nut |
| 3 | Collet (optional accessory) |

Proceed as follows to change the tool:

- ➡ Use the hook wrench to unfasten the clamping nut **and** the collet.
 - 🔧 Make use of the hook wrench from the scope of delivery of the HF spindle.
- ➡ Remove the tool.
- ➡ Screw the clamping nut out.
- ➡ Remove the collet from the taper of the mount.

Note: Ensure functionality.

All contamination damages the collet, clamping nut, tool mount, etc. As a result, the function of the HF spindle is no longer guaranteed.

- ▶ Clean the collet.
- ▶ Clean the clamping nut.
- ▶ Clean the thread of the shaft.
- ▶ Clean the inner taper of the shaft.

- ➔ Lightly grease the thread of the clamping nut.
- ➔ Push the collet into the taper of the mount.
- ➔ Insert the tool.
- ➔ Make sure that the shank of the clamped tool does not press on the inner stop of the tool mount once the clamping nut has been tightened.
- ➔ To prevent the clamping nut from loosening, tighten it again after a short period of operation and when the shaft is at a standstill.

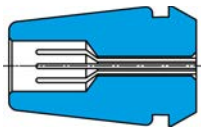
10.2.1

Short clamping bore

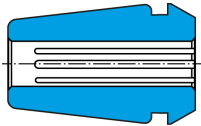

Continuous clamping bore

Maximum tightening torques

Excessive tightening torques (M_A) can damage or destroy the collet, clamping nut, and collet mount of the shaft.

Keep to the following values.

- ➔ Short clamping bore
 - ↻ Clamping diameter: 1,0 - 2,5 mm
 - ↻ M_a max.: 5 Nm
- ➔ Continuous clamping bore
 - ↻ Clamping diameter: 3,0 - 5,0 mm
 - ↻ M_a max.: 8 Nm

11



Tools for high speed cutting

DANGER: Due to flying parts.

If the wrong direction of rotation is used, the tool is damaged when load is applied. The centrifugal forces cause the broken part to be flung out.

- ▶ Only use tools with the correct direction of rotation for the HF spindle.



DANGER: Due to flying parts.

If the speed is selected incorrectly, the HF spindle or the tool may be destroyed and their fragments may be flung out.

- ▶ Note the maximum speed for the selected tool.
- ▶ Note the maximum speed for the HF spindle.
- ▶ The maximum permissible speed of the HF spindle for commissioning / processing is always the **lowest** specified speed.

- ➔ Only use tools that are technically sound.
- ➔ Only use tools with a tool shank diameter that corresponds to the inner diameter of the collet. For example, do not use shanks with a diameter of 3 mm in collets for 1/8" (=3.175 mm).
 - ↳ Also see the Technical Specifications [▶ 12] section
- ➔ Only use tool shanks with a diameter tolerance of h6.
- ➔ Do not use tool shanks with a clamping surface (e.g. Weldon).
- ➔ Only use a balanced tool.
 - ↳ DIN ISO 1940, balance grade 2,5 .

12 Maintenance

Only specialist personnel may perform maintenance on the spindle.

The HF spindle must be shut down before any maintenance work.

- Make sure that the shaft of the HF spindle has come to an absolute standstill.
- Before carrying out any work, read the corresponding section of the manual carefully again.
- Observe the manual of the machine in which the HF spindle is installed.
- Observe all safety instructions and safety rules.

12.1 Ball bearings



Note: Foreign matter reduces the service life.

The HF spindle bearings have lifetime grease lubrication. This means that they do not require maintenance.

- ▶ Do not lubricate the ball bearings.
- ▶ Do not apply grease, oil, or cleaning agents to the openings of the HF spindle.

12.2 Daily cleaning

To ensure that the HF spindle functions safely and accurately, all contact surfaces of the HF spindle, the mount for the HF spindle, the tool mount, and the tool holder must be clean.



Note: Foreign matter reduces the service life.

- ▶ Do not use compressed air to clean the HF spindle.
- ▶ Do not use ultrasonic cleaning on the HF spindle.
- ▶ Do not use steam jets to clean the HF spindle.

This could cause contamination to enter the bearing area.

12.2.1 Before commencing work

- Check that all surfaces are thoroughly cleaned and free of dust, grease, coolant, machining residues, and metal particles.
- Check that the HF spindle is free of damage.
- If the HF spindle is equipped with sealing air, always switch this on during cleaning.
- Only use a clean, soft cloth or a clean, soft brush for cleaning.

12.2.2 With every tool change

- Ensure that the tool mount and tool shank are clean.
 - ↳ Remove any soiling.

12.2.3 Every time the clamping device is changed

- ➔ Clean the inner taper of the HF spindle shaft. The inner taper must be free of chips and contamination.
- ➔ Clean the tool taper.
- ➔ Apply a light greasy film to the taper of the collet after cleaning.
 - ✎ Only use the collet grease from the service set.

This improves the sliding movement and increases the clamping force of the collet.

12.3 In the case of storage

If the HF spindle is not required for a prolonged period of time:

- ➔ Store the HF spindle in horizontal position.
- ➔ Store the HF spindle so that it is protected from moisture, dust, and other environmental influences.
- ➔ Note the following storage conditions.

| | |
|---------------------------------|-------------------|
| Temperature of storage location | +10°C ... + 45° C |
| Relative humidity | < 50 % |

12.4 Monthly maintenance

- ➔ Turn the shaft of the HF spindle at least ten times by hand every four weeks.

12.5 Long periods of storage

- ➔ Turn the shaft of the HF spindle at least ten times by hand every three months.
- ➔ Then put the HF spindle into operation with a tool inserted for approx. 10 minutes.
 - ✎ The speed should be no more than 20 % of the maximum permissible speed for the HF spindle. (See Commissioning [▶ 24] section)

12.6 Maximum storage time

The maximum storage time is 2 years.

- ➔ Make sure that all information in the "Long periods of storage [▶ 30]" section is adhered to. This is the only way in which to maintain the functionality of the HF spindle.

13 Dismantling

Proceed as follows to remove the HF spindle:

- ➔ Completely disconnect the power supply.
- ➔ Completely disconnect the media supply (air and liquid).
- ➔ Make sure that the shaft of the HF spindle has come to an absolute standstill.
- ➔ Remove all connections from the HF spindle.
- ➔ Remove the HF spindle from the machine.

13.1 Disposal and environmental protection



More than 90% of the materials used in the HF spindle can be recycled (aluminum, stainless steel, steel, copper, etc.)

The HF spindle may not be disposed of with normal domestic waste.

- ➔ Remove all non-recyclable materials.
- ➔ Dispose of the HF spindle as scrap at an approved recycling facility.
- ➔ Follow all rules of the responsible administrative bodies.

If the HF spindle cannot be dismantled, send the HF spindle to **Nakanishi Jaeger GmbH**. **Nakanishi Jaeger GmbH** shall not assume the costs incurred for shipment and the fees for the recycling facilities.

14 Service and repairs



DANGER: Electric shock.

Electric shock can lead to severe burns and life-threatening injuries.

Take measures to prevent hazards caused by electrical energy (for details refer e.g. to the regulations issued by the VDE and the local energy supply companies).

- ▶ Before commencing work, switch off the power supply of the HF spindle.



Note: Damage due to electrostatic discharge.

Do not touch the electrostatic-sensitive components of the HF spindle.

14.1 Service partners

Only certified service partners may open and repair the spindle. Failure to comply with this voids any warranty claims and compensation claims for damages.

- ➔ The list of partners can be found on the following website.

<https://www.nakanishi-jaeger.com/en/contact/service-partners>

14.2

Malfunctions

The list below can be used to quickly investigate and eliminate faults.

HF spindle not rotating

| Cause | Troubleshooting |
|---------------------------------------|---|
| No power supply | <ul style="list-style-type: none"> <input type="checkbox"/> Check the frequency converter. <input type="checkbox"/> Check the machine. <input type="checkbox"/> Check all electrical connections. <input type="checkbox"/> Check all wires in the motor cable. <input type="checkbox"/> Activate the Start/Reset button. |
| Thermal protection has been activated | <ul style="list-style-type: none"> <input type="checkbox"/> Wait until the HF spindle has cooled down. <input type="checkbox"/> Check the frequency converter for error messages. If no messages are illuminated, start the frequency converter. (See also "Spindle becomes hot [▶ 32]") |
| Frequency converter has shut down | <ul style="list-style-type: none"> <input type="checkbox"/> Check the error messages in the frequency converter manual. |

HF spindle becomes hot

| Cause | Troubleshooting |
|-------------------------------------|--|
| Insufficient cooling | <ul style="list-style-type: none"> <input type="checkbox"/> Check the power of the chiller. <input type="checkbox"/> Check the water level of the chiller. <input type="checkbox"/> Check the connections and the cooling hoses. <input type="checkbox"/> Check the cooling circuit. <input type="checkbox"/> Check the chiller for error messages. |
| Phase missing | <ul style="list-style-type: none"> <input type="checkbox"/> Check all wires in the motor cable for cable breaks. |
| Machining too heavy | <ul style="list-style-type: none"> <input type="checkbox"/> Check the rotational direction of the HF spindle. <input type="checkbox"/> Check the rotational direction of the tool. <input type="checkbox"/> Check the tool for damage. <input type="checkbox"/> Reduce the machining load intensity. |
| Frequency converter incorrectly set | <ul style="list-style-type: none"> <input type="checkbox"/> Compare the values for the HF spindle with the set values on the frequency converter. |

HF spindle becomes loud

| Cause | Troubleshooting |
|---|--|
| Tool unsuitable | <ul style="list-style-type: none"> <input type="checkbox"/> Only use balanced tools. (Also see the "Tools for high speed cutting [▶ 28]" section.) <input type="checkbox"/> Check the tool for damage. <input type="checkbox"/> Replace damaged tool. |
| HF spindle is not clamped truly or is distorted | <ul style="list-style-type: none"> <input type="checkbox"/> Only use spindle holders from the original accessories or holders produced according to the tolerances specified by Nakanishi Jaeger GmbH. |
| HF spindle clamped too tightly | <ul style="list-style-type: none"> <input type="checkbox"/> Only tighten the clamping screws of the spindle holder manually. <input type="checkbox"/> Do not use technical aids to clamp the HF spindle. |
| Bearings damaged | <ul style="list-style-type: none"> <input type="checkbox"/> Contact Nakanishi Jaeger GmbH service. |

Sensor does not send any signals

| Cause | Troubleshooting |
|-------------------------|---|
| No connection to sensor | <ul style="list-style-type: none"> <input type="checkbox"/> Check the lines and connections. |

**HF spindle vibrates/
oscillates**

| Cause | Troubleshooting |
|-------------------------------------|---|
| Tool unsuitable | <input type="checkbox"/> Only use balanced tools. (Also see the "Tools for high speed cutting [▶ 28]" section.) <input type="checkbox"/> Check whether the tool is suitable for the application. <input type="checkbox"/> Check the tool for damage. <input type="checkbox"/> Replace damaged tool. |
| Contamination | <input type="checkbox"/> Remove all contamination between the tool taper and shaft of the HF spindle. (Observe all points in the "Tool change [▶ 26]" and "Maintenance [▶ 29]" sections.) |
| Frequency converter incorrectly set | <input type="checkbox"/> Compare the values for the HF spindle with the set values on the frequency converter. |
| Machining too heavy | <input type="checkbox"/> Reduce the machining load intensity. |
| Mounting screws are loose | <input type="checkbox"/> Tighten the screws securely. |
| HF spindle damaged | <input type="checkbox"/> Contact Nakanishi Jaeger GmbH service. |

If the error is not rectified after checking all of the points, contact the relevant service partner.

- ➔ Request the accompanying note for the repair from the service partner.
- ➔ Check the manual of the machine.
- ➔ Contact the manufacturer of the machine.

15**Declaration of Incorporation**

The safety instructions of the product documentation supplied must be observed.

Under the EC Machinery Directive

Nakanishi Jaeger GmbH

SF-Elektromaschinenbau

Siemensstr. 8

D-61239 Ober-Mörlen

Tel. +49 (0) 60029123 -0

hereby declare that the product,

| | |
|------------|-------------------------|
| Product | High Frequency Spindle |
| Type | Z33-M060.51 K0,15 S15 |
| Serial no. | See last page of manual |

as far as possible from the supplied, complies with the essential requirements of the Machinery Directive 2006/42/EC.

Sections of the Machinery Directive have been applied: 1.1.1; 1.1.2; 1.1.5; 1.3.2; 1.3.4; 1.5.1; 1.5.2; 1.5.4; 1.5.5; 1.5.6; 1.5.8; 1.5.9; 1.6.4; 1.6.5; 1.7.1; 1.7.1.1; 1.7.2; 1.7.3; 1.7.4;

The incomplete machinery in its standard design complies furthermore with the following applicable regulations:

| | |
|---------------------------------|--|
| Applicable harmonized standards | DIN EN ISO 12100 Safety of machines |
|---------------------------------|--|

The machinery is incomplete and must not be put into service until the machinery into which it is to be incorporated has been declared in conformity with the provisions of the Machinery Directive 2006/42/EC and any other applicable regulations.

We at Nakanishi Jaeger GmbH agree to submit the special documents for incomplete machines to national authorities upon request.

The special technical documentation referred to in Annex VII, Part B, belonging to the machine has been created.

Person who is authorized to compile the documents listed in Annex VII, Part B:

Nakanishi Jaeger GmbH

Ober-Mörlen, 01.09.2023



Nakanishi Jaeger YouTube channel

Scan this QR code with any QR code scanner.



Nakanishi Jaeger GmbH

Siemensstraße 8
61239 Ober-Mörlen
GERMANY

☎ +49 (0)6002-9123-0
✉ sales@anakanishi-jaeger.com
www.nakanishi-jaeger.com

Jaeger Spindles North America, Corp.

6611 Bay Circle, Suite 165
Norcross, GA 30071
USA

☎ +1 (770) 674-4480
✉ office@jaegerspindles.com
www.nakanishi-jaeger.com/en

Serial number

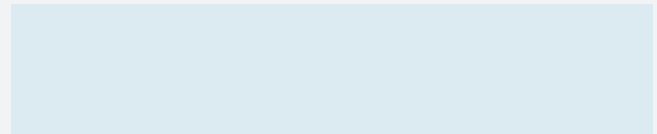

Type **Z33-M060.51 K0,15 S15**

Item no. **15201039-02**

Revision 03 Date 01.09.2023

Language EN

